

Data sheet | Item number: 765-1102/100-000

16-channel digital input/output; Profinet; 16 Configurable DIO; DC 24 V / 2.0 A; 8xM12 connection; WideLine

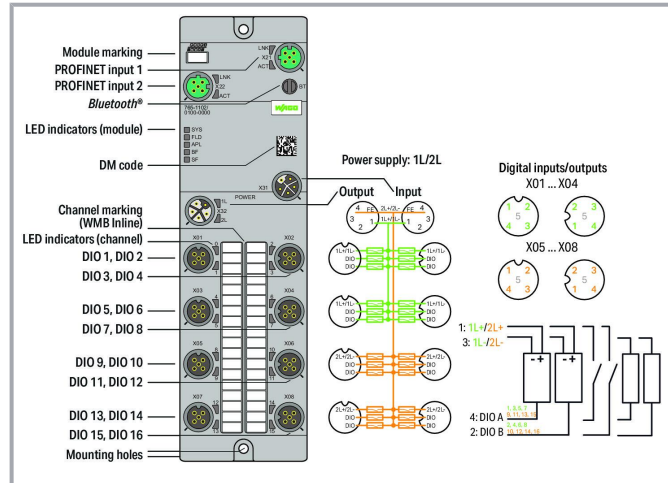

www.wago.com/765-1102_100-000



Data
Technical data

Fieldbus

Communication	PROFINET
Connection technology: communication/fieldbus	2 x D-coded M12; 4-pole
Interface standard	10BASE-T/100BASE-TX; potential-free
Autonegotiation; autocrossover	yes
PROFINET IO properties	PROFINET IO device; 2-port switch, LLDP, MRP, SNMP

Device Functions

Parameter	Input filter Output current Temperature
Diagnostics	Undervoltage; Overcurrent; Overload; Overtemperature

Subject to changes. Please also observe the further product documentation!

WAGO Corporation
Germantown, WI 53022
Phone: 1-800-DIN-RAIL (346-7245) | Fax: (262) 255-6222
Email: info.us@wago.com | Web: www.wago.us

Do you have any questions about our products?
We are always happy to take your call at (262) 255-6222 or 1 800-DIN-RAIL.



Device functions	Bluetooth® OPC UA Server
Visualization	Android/iOS app Webserver

Digital inputs/outputs

Number of digital inputs	16
Number of digital outputs	16
Connection technology: inputs / outputs	8 x A-coded M12; 5-pole
Voltage signal type	DC 24 V
Input characteristic	High-side switching
Input filter	0.2 ... 20 ms
Input characteristic	Type 3, per IEC 61131-2
Output current (per channel)	typ. 2 A for DO
Supply current per port	1L/2L: 4 A max.

Module Power Supply

Connection technology: supply	2 x L-coded M12; 5-pole
Supply voltage	24 VDC (18 ... 31.2 V); 1L/2L
Power consumption (max.)	16000 mA
Power consumption (note)	per supply line; overload- and short-circuit-protected
Reverse voltage protection	Yes

Geometrical Data

Width	60 mm / 2.362 inch
Height	30 mm / 1.181 inch
Depth	210 mm / 8.268 inch

Mechanical Data

Weight	610 g
Conformity marking	CE

Environmental Requirements

Surrounding air temperature (operation)	-25 ... 70 °C
Surrounding air temperature (storage)	-40 ... 80 °C
Protection type	IP67
Protection class	III per EN 61140, IEC 61140, VDE 0140-1

Subject to changes. Please also observe the further product documentation!

WAGO Corporation
Germantown, WI 53022
Phone: 1-800-DIN-RAIL (346-7245) | Fax: (262) 255-6222
Email: info.us@wago.com | Web: www.wago.us

Do you have any questions about our products?
We are always happy to take your call at (262) 255-6222 or 1 800-DIN-RAIL.

Operating altitude	0 ... 2000 m
Pollution degree (5)	3 per EN 60664-1
Overvoltage category	II (EN 60664-1)
Relative humidity (without condensation)	95 %
Vibration resistance	5g per IEC 60068-2-6
Shock resistance	Short-term: 50g/11 ms/half-sine per IEC 60068-2-27; Long-term: 30g/6 ms/half-sine per IEC 60068-2-29
EMC immunity to interference	per EN 61000-6-2
EMC emission of interference	per EN 61000-6-4

Commercial data



Packaging type	BOX
Country of origin	DE
GTIN	4055143949965
Customs tariff number	8537109170

Required accessories



Tools

	Item no.: 206-701 Torque wrench M8 and M12; Assembly kit	www.wago.com/206-701
---	--	--

Cover

	Item no.: 756-8102 M12 protective cap; for unused sockets	www.wago.com/756-8102
	Item no.: 756-8103 M12 protective cap; for unused plugs	www.wago.com/756-8103

Marking accessories

	Item no.: 2009-110 Marking strips; for Smart Printer; on reel; not stretchable; plain; snap-on type; white	www.wago.com/2009-110
	Item no.: 2009-115 WMB-Inline; for Smart Printer; 1500 pieces on roll; stretchable 5 - 5.2 mm; plain; snap-on type; white	www.wago.com/2009-115













Optional accessories

Cables and pluggable connectors

	Item no.: 756-1201/060-020 ETHERNET cable; M12D plug; straight; 4-pole; Length: 2 m	www.wago.com/756-1201/060-020
--	---	--













Subject to changes. Please also observe the further product documentation!



	Item no.: 756-1201/060-050 ETHERNET cable; M12D plug; straight; 4-pole; Length: 5 m	www.wago.com/756-1201/060-050
	Item no.: 756-1201/060-100 ETHERNET cable; M12D plug; straight; 4-pole; Length: 10 m	www.wago.com/756-1201/060-100
	Item no.: 756-1201/060-200 ETHERNET cable; M12D plug; straight; 4-pole; Length: 20 m	www.wago.com/756-1201/060-200
	Item no.: 756-1202/060-020 ETHERNET cable; M12D plug; angled; 4-pole; Length: 2 m	www.wago.com/756-1202/060-020
	Item no.: 756-1202/060-050 ETHERNET cable; M12D plug; angled; 4-pole; Length: 5 m	www.wago.com/756-1202/060-050
	Item no.: 756-1202/060-100 ETHERNET cable; M12D plug; angled; 4-pole; Length: 10 m	www.wago.com/756-1202/060-100
	Item no.: 756-1202/060-200 ETHERNET cable; M12D plug; angled; 4-pole; Length: 20 m	www.wago.com/756-1202/060-200
	Item no.: 756-1203/060-020 ETHERNET cable; M12D plug; straight; M12 plug, axial; 4-pole; Length: 2 m	www.wago.com/756-1203/060-020
	Item no.: 756-1203/060-050 ETHERNET cable; M12D plug; straight; M12 plug, axial; 4-pole; Length: 5 m	www.wago.com/756-1203/060-050
	Item no.: 756-1203/060-100 ETHERNET cable; M12D plug; straight; M12 plug, axial; 4-pole; Length: 10 m	www.wago.com/756-1203/060-100
	Item no.: 756-1203/060-200 ETHERNET cable; M12D plug; straight; M12 plug, axial; 4-pole; Length: 20 m	www.wago.com/756-1203/060-200
	Item no.: 756-1204/060-010 ETHERNET/PROFINET cable, angled; 1 m; fitted on both ends; D-coded; M12 plug, angled; M12 plug, angled	www.wago.com/756-1204/060-010
	Item no.: 756-1204/060-020 ETHERNET cable; M12D plug; angled; M12 plug, right angle; 4-pole; Length: 2 m	www.wago.com/756-1204/060-020













Subject to changes. Please also observe the further product documentation!



	Item no.: 756-1204/060-030 ETHERNET cable; M12D plug; angled; M12 plug, right angle; 4-pole; Length: 3 m	www.wago.com/756-1204/060-030
	Item no.: 756-1204/060-050 ETHERNET cable; M12D plug; angled; M12 plug, right angle; 4-pole; Length: 5 m	www.wago.com/756-1204/060-050
	Item no.: 756-1204/060-100 ETHERNET cable; M12D plug; angled; M12 plug, right angle; 4-pole; Length: 10 m	www.wago.com/756-1204/060-100
	Item no.: 756-1204/060-200 ETHERNET cable; M12D plug; angled; M12 plug, right angle; 4-pole; Length: 20 m	www.wago.com/756-1204/060-200
	Item no.: 756-3501/050-020 Power cable; M12L socket; straight; 5-pole; Length: 2 m	www.wago.com/756-3501/050-020
	Item no.: 756-3501/050-050 Power cable; M12L socket; straight; 5-pole; Length: 5 m	www.wago.com/756-3501/050-050
	Item no.: 756-3501/050-075 Power cable; M12L socket; straight; 5-pole; Length: 7.5 m	www.wago.com/756-3501/050-075
	Item no.: 756-3501/050-100 Power cable; M12L socket; straight; 5-pole; Length: 10 m	www.wago.com/756-3501/050-100
	Item no.: 756-3501/050-150 Power cable; M12L socket; straight; 5-pole; Length: 15 m	www.wago.com/756-3501/050-150
	Item no.: 756-3502/050-020 Power cable; M12L socket; angled; 5-pole; Length: 2 m	www.wago.com/756-3502/050-020
	Item no.: 756-3502/050-050 Power cable; M12L socket; angled; 5-pole; Length: 5 m	www.wago.com/756-3502/050-050
	Item no.: 756-3502/050-075 Power cable; M12L socket; angled; 5-pole; Length: 7.5 m	www.wago.com/756-3502/050-075
	Item no.: 756-3502/050-100 Power cable; M12L socket; angled; 5-pole; Length: 10 m	www.wago.com/756-3502/050-100

Subject to changes. Please also observe the further product documentation!



	Item no.: 756-3502/050-150 Power cable; M12L socket; angled; 5-pole; Length: 15 m	www.wago.com/756-3502/050-150
	Item no.: 756-3503/050-020 Power cable; M12L plug; straight; 5-pole; Length: 2 m	www.wago.com/756-3503/050-020
	Item no.: 756-3503/050-050 Power cable; M12L plug; straight; 5-pole; Length: 5 m	www.wago.com/756-3503/050-050
	Item no.: 756-3503/050-075 Power cable; M12L plug; straight; 5-pole; Length: 7.5 m	www.wago.com/756-3503/050-075
	Item no.: 756-3503/050-100 Power cable; M12L plug; straight; 5-pole; Length: 10 m	www.wago.com/756-3503/050-100
	Item no.: 756-3503/050-150 Power cable; M12L plug; straight; 5-pole; Length: 15 m	www.wago.com/756-3503/050-150
	Item no.: 756-3504/050-020 Power cable; M12L plug; angled; 5-pole; Length: 2 m	www.wago.com/756-3504/050-020
	Item no.: 756-3504/050-050 Power cable; M12L plug; angled; 5-pole; Length: 5 m	www.wago.com/756-3504/050-050
	Item no.: 756-3504/050-075 Power cable; M12L plug; angled; 5-pole; Length: 7.5 m	www.wago.com/756-3504/050-075
	Item no.: 756-3504/050-100 Power cable; M12L plug; angled; 5-pole; Length: 10 m	www.wago.com/756-3504/050-100
	Item no.: 756-3504/050-150 Power cable; M12L plug; angled; 5-pole; Length: 15 m	www.wago.com/756-3504/050-150
	Item no.: 756-3505/050-003 Power cable; M12L socket; straight; M12L plug; straight; 5-pole; Length: 0.3 m	www.wago.com/756-3505/050-003
	Item no.: 756-3505/050-005 Power cable; M12L socket; straight; M12L plug; straight; 5-pole; Length: 0.5 m	www.wago.com/756-3505/050-005

Subject to changes. Please also observe the further product documentation!

WAGO Corporation
Germantown, WI 53022
Phone: 1-800-DIN-RAIL (346-7245) | Fax: (262) 255-6222
Email: info.us@wago.com | Web: www.wago.us

Do you have any questions about our products?
We are always happy to take your call at (262) 255-6222 or 1 800-DIN-RAIL.



↪	Item no.: 756-3505/050-010 Power cable; M12L socket; straight; M12L plug; straight; 5-pole; Length: 1 m	www.wago.com/756-3505/050-010
↪	Item no.: 756-3505/050-020 Power cable; M12L socket; straight; M12L plug; straight; 5-pole; Length: 2 m	www.wago.com/756-3505/050-020
↪	Item no.: 756-3505/050-050 Power cable; M12L socket; straight; M12L plug; straight; 5-pole; Length: 5 m	www.wago.com/756-3505/050-050
↪	Item no.: 756-3505/050-075 Power cable; M12L socket; straight; M12L plug; straight; 5-pole; Length: 7.5 m	www.wago.com/756-3505/050-075
↪	Item no.: 756-3505/050-100 Power cable; M12L socket; straight; M12L plug; straight; 5-pole; Length: 10 m	www.wago.com/756-3505/050-100
↪	Item no.: 756-3505/050-150 Power cable; M12L socket; straight; M12L plug; straight; 5-pole; Length: 15 m	www.wago.com/756-3505/050-150
↪	Item no.: 756-3506/050-003 Power cable; M12L socket; angled; M12L plug; angled; 5-pole; Length: 0.3 m	www.wago.com/756-3506/050-003
↪	Item no.: 756-3506/050-005 Power cable; M12L socket; angled; M12L plug; angled; 5-pole; Length: 0.5 m	www.wago.com/756-3506/050-005
↪	Item no.: 756-3506/050-010 Power cable; M12L socket; angled; M12L plug; angled; 5-pole; Length: 1 m	www.wago.com/756-3506/050-010
↪	Item no.: 756-3506/050-020 Power cable; M12L socket; angled; M12L plug; angled; 5-pole; Length: 2 m	www.wago.com/756-3506/050-020
↪	Item no.: 756-3506/050-050 Power cable; M12L socket; angled; M12L plug; angled; 5-pole; Length: 5 m	www.wago.com/756-3506/050-050
↪	Item no.: 756-3506/050-075 Power cable; M12L socket; angled; M12L plug; angled; 5-pole; Length: 7.5 m	www.wago.com/756-3506/050-075
↪	Item no.: 756-3506/050-100 Power cable; M12L socket; angled; M12L plug; angled; 5-pole; Length: 10 m	www.wago.com/756-3506/050-100

Subject to changes. Please also observe the further product documentation!



↻	Item no.: 756-3506/050-150 Power cable; M12L socket; angled; M12L plug; angled; 5-pole; Length: 15 m	www.wago.com/756-3506/050-150
✓	Item no.: 756-5311/040-015 Sensor/Actuator cable; M12A plug; straight; 4-pole; Length: 1.5 m	www.wago.com/756-5311/040-015
✓	Item no.: 756-5311/040-050 Sensor/Actuator cable; M12A plug; straight; 4-pole; Length: 5 m	www.wago.com/756-5311/040-050
✓	Item no.: 756-5311/040-100 Sensor/Actuator cable; M12A plug; straight; 4-pole; Length: 10 m	www.wago.com/756-5311/040-100
✓	Item no.: 756-5312/040-015 Sensor/Actuator cable; M12B socket; straight; 4-pole; Length: 1.5 m	www.wago.com/756-5312/040-015
✓	Item no.: 756-5312/040-050 Sensor/Actuator cable; M12B socket; straight; 4-pole; Length: 5 m	www.wago.com/756-5312/040-050
✓	Item no.: 756-5312/040-100 Sensor/Actuator cable; M12B socket; straight; 4-pole; Length: 10 m	www.wago.com/756-5312/040-100
↻	Item no.: 756-5401/040-010 Sensor/Actuator cable; M12A socket; straight; M12A plug; straight; 4-pole; Length: 1 m	www.wago.com/756-5401/040-010
↻	Item no.: 756-5401/040-020 Sensor/Actuator cable; M12A socket; straight; M12A plug; straight; 4-pole; Length: 2 m	www.wago.com/756-5401/040-020
↻	Item no.: 756-5402/040-010 Sensor/Actuator cable; M12A socket; straight; M12A plug; angled; 4-pole; Length: 1 m	www.wago.com/756-5402/040-010
↻	Item no.: 756-5402/040-020 Sensor/Actuator cable; M12A socket; straight; M12A plug; angled; 4-pole; Length: 2 m	www.wago.com/756-5402/040-020
↻	Item no.: 756-5403/040-010 Sensor/Actuator cable; M12A socket; angled; M12A plug; straight; 4-pole; Length: 1 m	www.wago.com/756-5403/040-010
↻	Item no.: 756-5403/040-020 Sensor/Actuator cable; M12A socket; angled; M12A plug; straight; 4-pole; Length: 2 m	www.wago.com/756-5403/040-020

Subject to changes. Please also observe the further product documentation!

WAGO Corporation
Germantown, WI 53022
Phone: 1-800-DIN-RAIL (346-7245) | Fax: (262) 255-6222
Email: info.us@wago.com | Web: www.wago.us













Do you have any questions about our products?
We are always happy to take your call at (262) 255-6222 or 1 800-DIN-RAIL.



Item no.: 756-5404/040-010 Sensor/Actuator cable; M12A socket; angled; M12A plug; angled; 4-pole; Length: 1 m	www.wago.com/756-5404/040-010
Item no.: 756-5404/040-020 Sensor/Actuator cable; M12A socket; angled; M12A plug; angled; 4-pole; Length: 2 m	www.wago.com/756-5404/040-020
Item no.: 756-5507/040-010 Sensor/Actuator cable; M8 socket; straight; M12A plug; straight; 4-pole; Length: 1 m	www.wago.com/756-5507/040-010
Item no.: 756-5507/040-020 Sensor/Actuator cable; M8 socket; straight; M12A plug; straight; 4-pole; Length: 2 m	www.wago.com/756-5507/040-020
Item no.: 756-5508/040-010 Sensor/Actuator cable; M8 socket; straight; M12A plug; angled; 4-pole; Length: 1 m	www.wago.com/756-5508/040-010
Item no.: 756-5508/040-020 Sensor/Actuator cable; M8 socket; straight; M12A plug; angled; 4-pole; Length: 2 m	www.wago.com/756-5508/040-020
Item no.: 756-5509/040-010 Sensor/Actuator cable; M8 socket; angled; M12A plug; straight; 4-pole; Length: 1 m	www.wago.com/756-5509/040-010
Item no.: 756-5509/040-020 Sensor/Actuator cable; M8 socket; angled; M12A plug; straight; 4-pole; Length: 2 m	www.wago.com/756-5509/040-020
Item no.: 756-5510/040-010 Sensor/Actuator cable; M8 socket; angled; M12A plug; angled; 4-pole; Length: 1 m	www.wago.com/756-5510/040-010
Item no.: 756-5510/040-020 Sensor/Actuator cable; M8 socket; angled; M12A plug; angled; 4-pole; Length: 2 m	www.wago.com/756-5510/040-020
Item no.: 756-5513/040-010 Sensor/Actuator cable; 2xM8 socket; straight; M12A plug; straight; 4-pole; Length: 1 m	www.wago.com/756-5513/040-010
Item no.: 756-5513/040-020 Sensor/Actuator cable; 2xM8 socket; straight; M12A plug; straight; 4-pole; Length: 2 m	www.wago.com/756-5513/040-020
Item no.: 756-5514/040-010 Sensor/Actuator cable; 2xM8 socket; angled; M12A plug; straight; 4-pole; Length: 1 m	www.wago.com/756-5514/040-010

Subject to changes. Please also observe the further product documentation!



	Item no.: 756-5514/040-020 Sensor/Actuator cable; 2xM8 socket; angled; M12A plug; straight; 4-pole; Length: 2 m	www.wago.com/756-5514/040-020
	Item no.: 756-5516/040-010 Sensor/Actuator cable; 2xM12 socket; straight; M12A plug; straight; 4-pole; Length: 1 m	www.wago.com/756-5516/040-010
	Item no.: 756-5516/040-020 Sensor/Actuator cable; 2xM12 socket; straight; M12A plug; straight; 4-pole; Length: 2 m	www.wago.com/756-5516/040-020
	Item no.: 756-5517/040-010 Sensor/Actuator cable; 2xM12 socket; angled; M12A plug; straight; 4-pole; Length: 1 m	www.wago.com/756-5517/040-010
	Item no.: 756-5517/040-020 Sensor/Actuator cable; 2xM12 socket; angled; M12A plug; straight; 4-pole; Length: 2 m	www.wago.com/756-5517/040-020
	Item no.: 756-9202/040-000 Accessories; 4-pole	www.wago.com/756-9202/040-000
	Item no.: 756-9205/040-000 Accessories; 4-pole	www.wago.com/756-9205/040-000
	Item no.: 756-9301/040-000 Accessories; 4-pole	www.wago.com/756-9301/040-000
	Item no.: 756-9301/050-000 Accessories; 5-pole	www.wago.com/756-9301/050-000
	Item no.: 756-9501/040-000 Accessories; M12 plug, right angle; 4-pole	www.wago.com/756-9501/040-000
	Item no.: 756-9501/060-000 Fitted pluggable connector; 4-pole, shielded; M12 plug, straight, D-coded; Spring	www.wago.com/756-9501/060-000
	Item no.: 756-9503/040-000 Accessories; 4-pole	www.wago.com/756-9503/040-000
	Item no.: 756-9504/040-000 Accessories; 4-pole	www.wago.com/756-9504/040-000

Subject to changes. Please also observe the further product documentation!



 **Item no.: 756-9701/050-000**
Fitted pluggable connector; 5-pole; M12 plug, straight; IDC technology

www.wago.com/756-9701/050-000

 **Item no.: 756-9711/050-000**
Fitted pluggable connector; 5-pole; M12 socket, straight; IDC technology

www.wago.com/756-9711/050-000

Downloads

Documentation

Manual

16-Channel Digital Input/Output; Profinet DC 24 V / 2.0 A; 8xM12 Connection; WideLine	V 2.1.0 Nov 30, 2020	pdf 3.9 MB	Download
--	-------------------------	---------------	----------

System Description

WAGO I/O System Field; General Product Information		pdf 708.2 kB	Download
--	--	-----------------	----------

CAD files

CAD data

2D/3D Models 765-1102/100-000		URL	Download
-------------------------------	--	-----	----------

CAE data

ZUKEN Portal 765-1102/100-000		URL	Download
-------------------------------	--	-----	----------

Device Files

Device Description File

750-916; GSD-Dateien der Version 2.x für PROFINET/ Serie 750/753, 765, 767 und 852	2.81 Apr 15, 2021	zip 2.4 MB	Download
--	----------------------	---------------	----------

Environmental Product Compliance

Compliance Search

Environmental Product Compliance 765-1102/100-000		URL	Download
---	--	-----	----------

Subject to changes. Please also observe the further product documentation!



16-channel digital input/output; Profinet; DC 24 V / 2.0 A; 8xM12 connection;
WideLine

Installation Notes

Product family

I/O System Field

[Show all products from the family](#)

Subject to changes. Please also observe the further product documentation!

WAGO Corporation
Germantown, WI 53022
Phone: 1-800-DIN-RAIL (346-7245) | Fax: (262) 255-6222
Email: info.us@wago.com | Web: www.wago.us

Do you have any questions about our products?
We are always happy to take your call at (262) 255-6222 or 1 800-DIN-RAIL.